

SEQUENCE® 1000

1000 Model 5100SEQ22

The Classic! The 1000 series has set the standard by which all others are measured. Perfect blend of medium pressure and ample flow for the majority of ponds. Motor is totally-enclosed, fan-cooled for durability. 115V or 230V. 3 year limited warranty. Made in USA. **Supplied with an 8-foot, 115V cordset.**

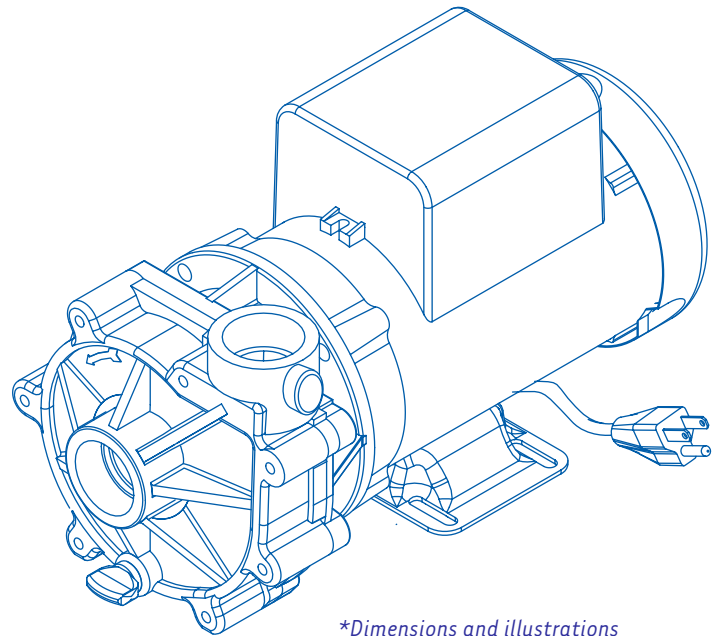
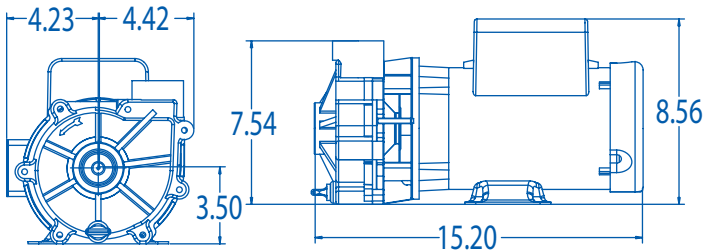

*Dimensions and illustrations are approximate and for reference only

Model 5100SEQ22	
List price	\$560.00
Inlet	1.5"
Discharge	1.5"
Max flow, GPH	5100
Max head, Ft	22'
Max Power, Watts	293
Max Current, Amps	3.03
115 / 230 @ Volts	115
Motor HP	1/3, 1/4, 1/6, 1/8
Motor Type	56J
Motor Enclosure	TEFC
Impeller	6
Shipping Weight	32.00 LBS
Box Dimensions	18 1/8" x 10" x 9 7/8"

(Low-Speed)

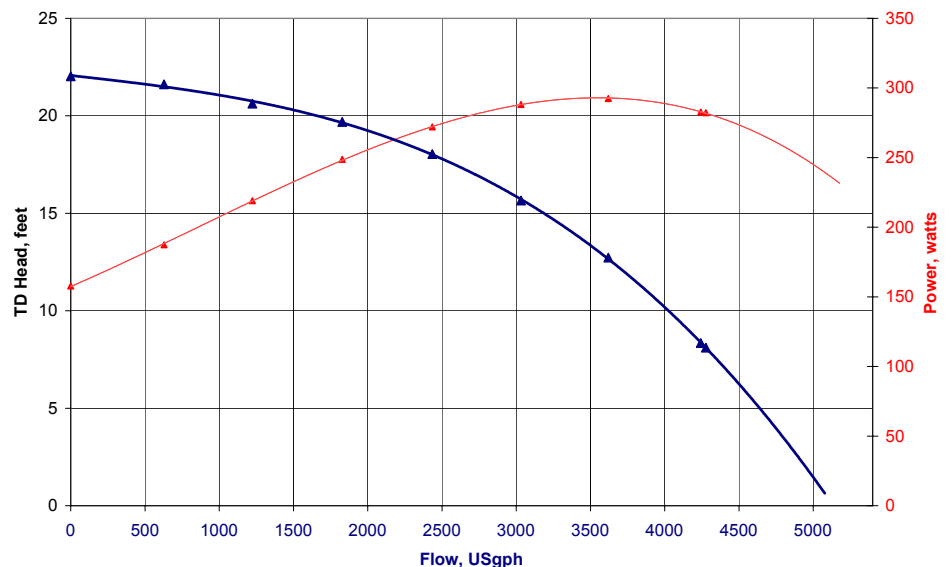

Proudly Made in the USA

Sustainable, Efficient.

©2008 SEQUENCE PUMPS A DIVISION OF MDM INC.